

KARIBAN

K444

Kapuzensweatshirt mit Reißverschluss

- Weichheit- und Komfort-Garantie.
- Konstruktion aus gebürstetem Fleece mit 3 Fäden und LSF-Behandlung für eine ausgezeichnete Veredelungs Oberfläche sowie eine ausgezeichnete Widerstandsfähigkeit und Stabilität beim Waschen.
- Im urbanen, entspannten Stil der Sweatshirtmarke LSF.

80% gekämmte Baumwolle / 20% Polyester 'LSF'. Vorgeschrumpfte Ware, innen angeraut. Silikon gewaschen. Kontrastfarbendes Nackenband. Kapuze innenseitig Dark Grey (Farbton Oxford Grey) oder Heather Grey (alle anderen Farben). Kängurutasche. Rippstrickbündchen. Reißverschluss. Zertifizierte STANDARD 100 by OEKO-TEX® N° CQ 1007/8, IFTH.



XS - S - M - L - XL - XXL - 3XL - 4XL



360 g/m²



Zusätzliche Informationen

Logistik



5



20



PK - Pakistan



61102099

Herkunftsland

Zolltarifnummer

Waschanleitung



Black

Dark Grey

Dark Khaki

Light Royal Blue

Navy

Oxford Grey

Red

White



KARIBAN

K444

Kapuzensweatshirt mit Reißverschluss

Maße

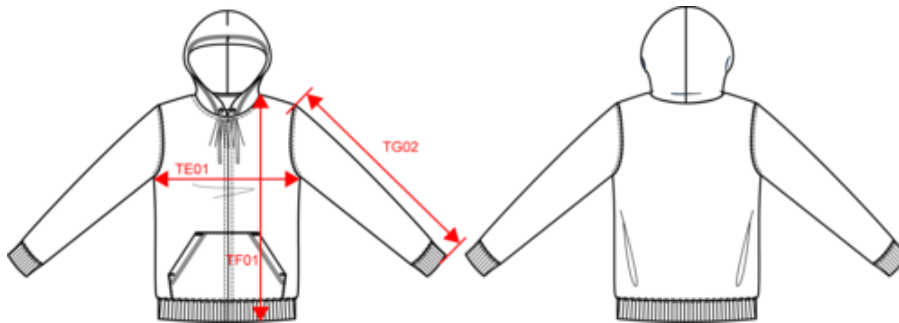









Measurements in cm	XS	S	M	L	XL	XXL	3XL	4XL
TE01 - 1/2 chest width at 1.5cm below armhole	51.00	54.00	57.00	60.00	63.00	66.00	69.00	72.00
TF01 - Total height from HSP	69.00	71.00	73.00	75.00	77.00	79.00	81.00	83.00
TG02 - Long sleeve length	63.50	65.00	67.00	68.00	69.50	71.00	72.50	74.00

KARIBAN

K444

Kapuzensweatshirt mit Reißverschluss

Farbinformationen

 Black RVB : 35,35,37 Pantone C : Black Pantone TCX : 19-4004TCX	 Dark Grey RVB : 63,60,60 Pantone C : 447C Pantone TCX : 19-0000TCX	 Dark Khaki RVB : 75,71,61 Pantone C : 418C Pantone TCX : 19-0414TCX	 Light Royal Blue RVB : 53,95,151 Pantone C : 653C Pantone TCX : 18-4041TCX	 Navy RVB : 41,46,56 Pantone C : 433C Pantone TCX : 19-4012TCX
 Oxford Grey RVB : Pantone C : Based on Cool gray 7C Pantone TCX : Based on 16-3850TCX	 Red RVB : 195,32,54 Pantone C : 200C Pantone TCX : 19-1664TCX	 White RVB : 236,236,252 Pantone C : White Pantone TCX : 11-0601TCX		

Logistik  5  20

Sizes	Width (cm)	Height (cm)	Length (cm)	Net weight (kg)	Gross weight (kg)	Pieces/Box	Pieces/Bundle
XS	40.00	40.00	60.00	12.10000	13.60000	20	5
S	40.00	40.00	60.00	13.40000	14.90000	20	5
M	40.00	40.00	60.00	13.80000	15.30000	20	5
L	40.00	44.00	60.00	14.60000	16.30000	20	5
XL	40.00	44.00	60.00	15.60000	17.30000	20	5
XXL	40.00	48.00	60.00	16.30000	18.00000	20	5
3XL	40.00	48.00	60.00	17.20000	19.00000	20	5
4XL	40.00	48.00	60.00	18.00000	19.80000	20	5